



Big Dutchman®



AirMaster & Co.

Wall fans with high air performance
and low power consumption

The successful **AirMaster** series

40 years of consistent enhancement and continuous growth according to customer needs

Fans of the AirMaster series have been an important part of the Big Dutchman product range for more than 40 years. They are the core of many ventilation systems and used by livestock farmers all over the world. And development still continues, of course. We know that barn dimensions increase continuously and that requirements regarding quality, pressure resistance, controllability and power consumption are rising.

Acknowledging these facts, we offer our AirMaster fans not only in different sizes, but also with the best accessories, new control principles and state-of-the-art control technology. This means that we can create the perfect ventilation system based on your wishes.

Our AirMaster fans are characterised by:

- high air performance;
- low power consumption;

- reduced maintenance costs;
- high resistance to corrosion;
- robustness.

Big Dutchman can easily implement an advanced and energy-saving ventilation system by combining different AirMaster types – for the benefit of your livestock. Let our experts advise you so you will find the best fan and ventilation system for your barn.

Features of the different AirMaster types

	Type of drive	Motor control	Shutter control	Housing material	Robustness	Highest motor efficiency	Best price : performance ratio	Highest corrosion resistance	Aerodynamic air inlet nozzle	Automatic emergency opening	Dynamic MultiStep
AirMaster 130	V-belt	on/off**	airflow	galvanized steel	✓	✓	✓	○	○	○	○
AirMaster 130C*	V-belt	on/off**	airflow	galvanized steel	✓	✓	✓	○	○	○	○
AirMaster 140	V-belt	on/off**	airflow	galvanized steel	✓	✓	✓	○	○	○	○
AirMaster 140C*	V-belt	on/off**	airflow	galvanized steel	✓	✓	✓	○	○	○	○
AirMaster Flex 140C*	V-belt	on/off**	motorized	polypropylene	✓	✓	✓	✓	✓	✓	○
AirMaster Blue 140C*	direct	controlled	motorized	polypropylene	✓	✓	○	✓	✓	✓	✓
AirMaster Blue 130	direct	controlled	motorized	polypropylene	✓	✓	○	✓	✓	✓	✓
AirMaster Blue 130C*	direct	controlled	motorized	polypropylene	✓	✓	○	✓	✓	✓	✓

* with cone

** controlled if required

Examples for ventilation systems with AirMaster fans

AirMaster fans must remove the warm and humid air that contains harmful gases from the barn, safely and reliably. Criteria for

selecting the ideal ventilation system include the length and width of the barn, the ventilation requirements of the livestock and

their age, the climatic conditions and energy consumption.

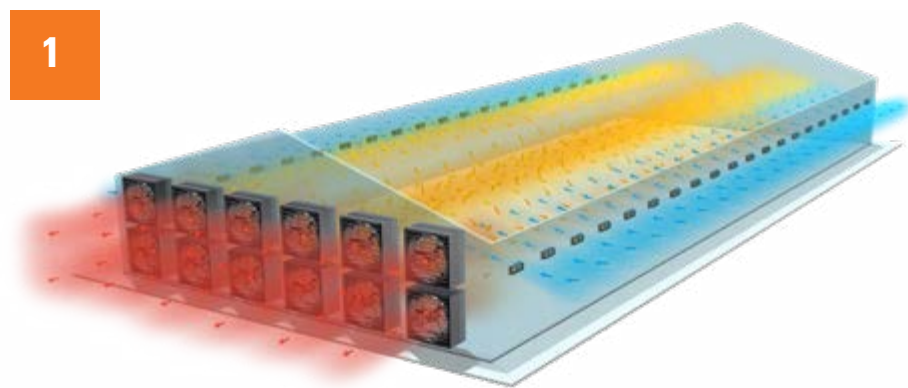

Gable ventilation, on/off

The exhaust air is exclusively removed through the gable, which is an effective and cost-efficient solution with our AirMaster 130 or 140 fans. Especially in regions with a temperate climate and livestock which are not affected when ventilation changes, this system is ideal. Depending on the ventilation level, the fans are switched on or off in steps.

2

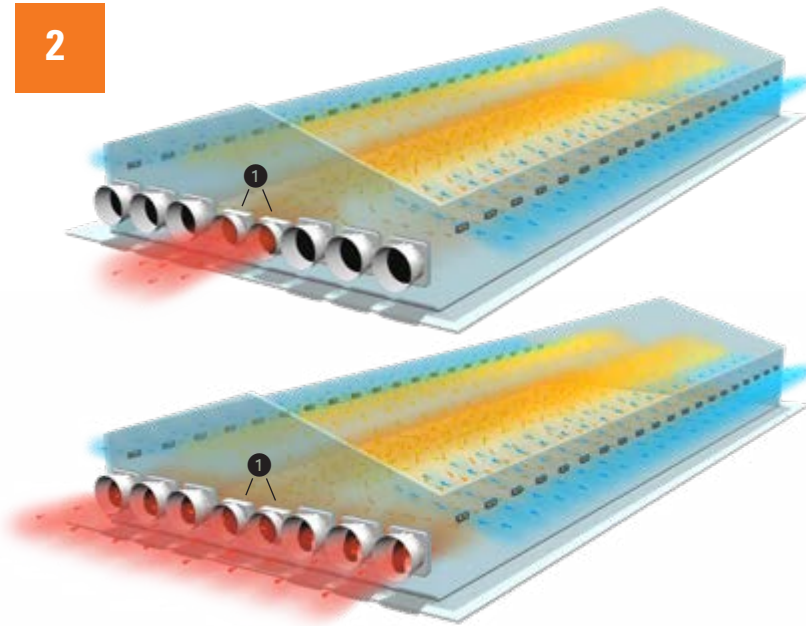

3

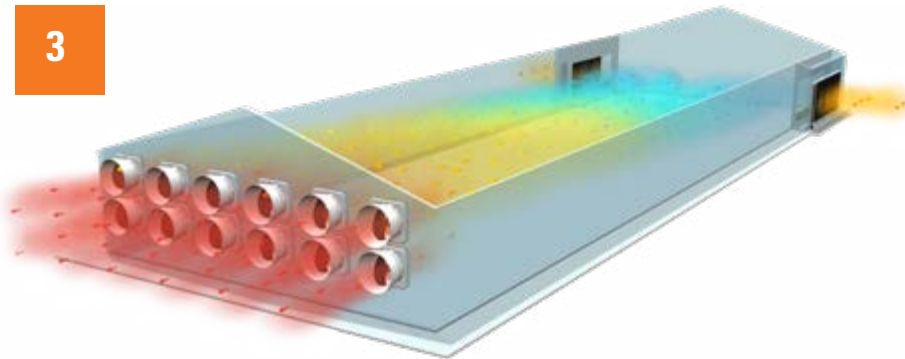

4

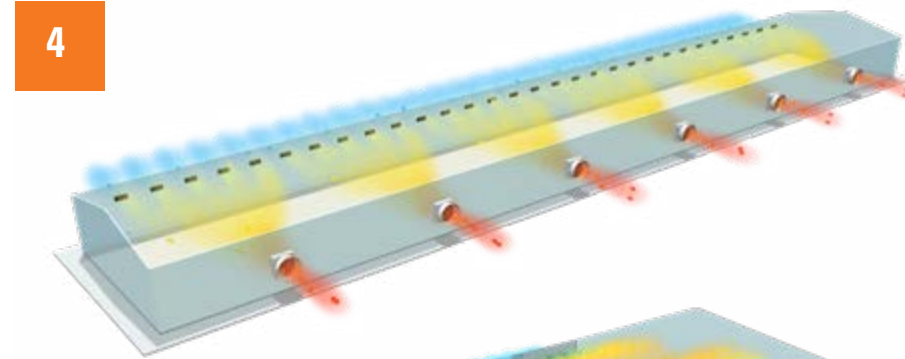

5

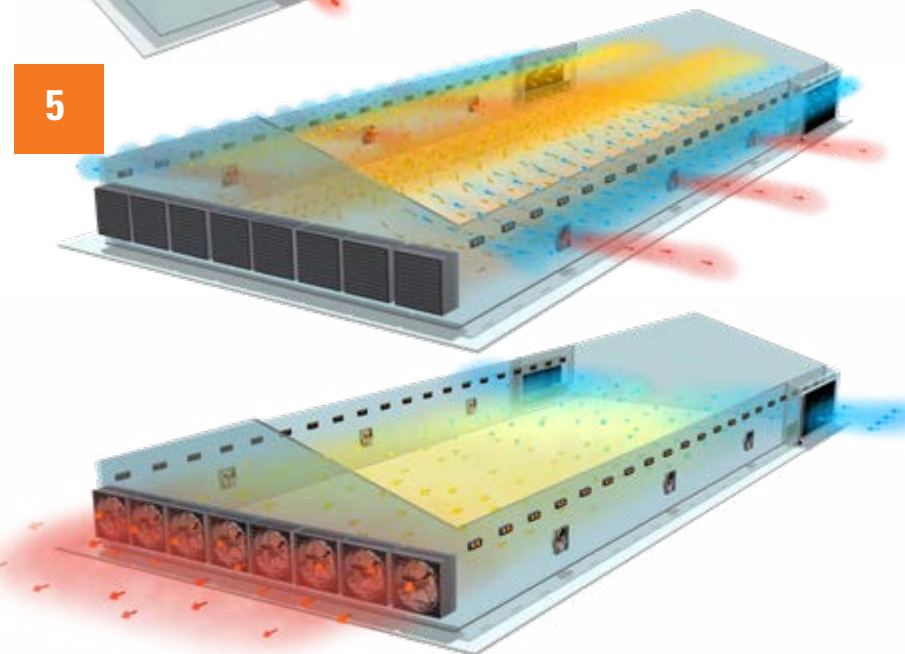

Gable ventilation, controlled

With this system, gable ventilation is realised with 130C/140C/Flex 140C on/off cone fans and two steplessly variable AirMaster Blue 130C fans ①.

Using the so-called stepless MultiStep principle, this combination makes it possible to control the ventilation level without greater jumps between the individual steps: the ideal solution for pullet rearing or broiler production in temperate climates, where a low ventilation level is required when the birds are first moved in. Based on the birds' growth, the ventilation rates can increase later.

When planning to use the Dynamic MultiStep control principle, all fans need to be controlled.

Tunnel ventilation, controlled or on/off

Tunnel ventilation with the AirMaster Blue 140C fans with controlled EC motors is an especially energy-saving solution in very warm climates. In such regions, the Dynamic MultiStep control principle is a good option.

Depending on the livestock type and the barn size, the AirMaster Flex 140C/140C/130C on/off fans may be another option.

Cross ventilation, controlled

Cross ventilation is a good solution in barns that are quite narrow. The AirMaster Blue 130 fans with or without cone can be controlled from 0 to 100 percent. Based on the ventilation level, the fans draw the air crosswise through the barn, thus ensuring uniform climate conditions everywhere.

CombiTunnel ventilation, controlled

In the **side mode** of CombiTunnel ventilation, the energy-saving AirMaster Blue 130 fans should be installed at both long sides of the barn.

In **tunnel mode**, the fans need to withstand a higher pressure than in side mode. The applied pressure depends on the length of the barn and the air speed. Consequently, the fans must be very heavy-duty and resistant to pressure so they can guarantee the required air change rate. For this application, Big Dutchman can offer the AirMaster 130/140 fans with or without cone and the AirMaster Flex 140C fan in the gable.

Step control

Simple and cost-efficient control principle

Controlling fans in steps is a good control principle to adjust the ventilation rate in the barn to your livestock's requirements. The AirMaster 130/140/Flex 140 on/off fans are the perfect solution here.

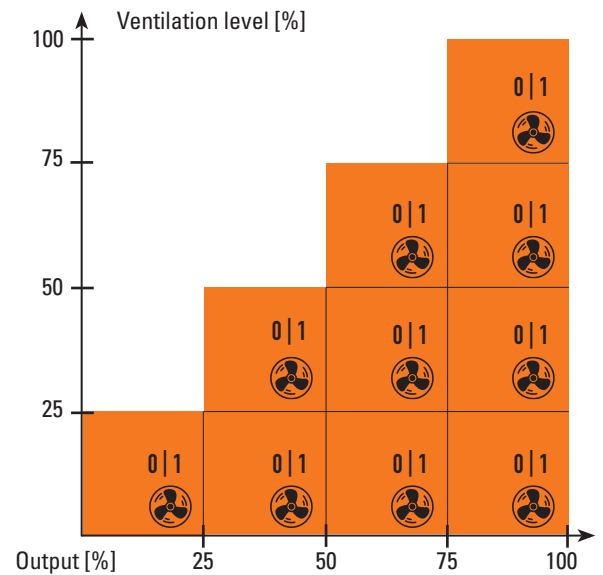
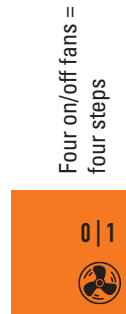

MultiStep and Dynamic MultiStep

Energy-saving control principles, can only be realised with the AirMaster Blue series

MultiStep combines stepless control and group control. The principle's advantage is a significant reduction in energy consumption while the same air performance can be maintained: electricity savings of up to 50 percent per year are possible. The entire ventilation system is more pressure-stable and less susceptible to wind. The climate computer controls just one fan steplessly from 0 to 100 percent and only starts up additional fans at full capacity (on/off method) when required. For the on/off method, the fans are divided into groups.

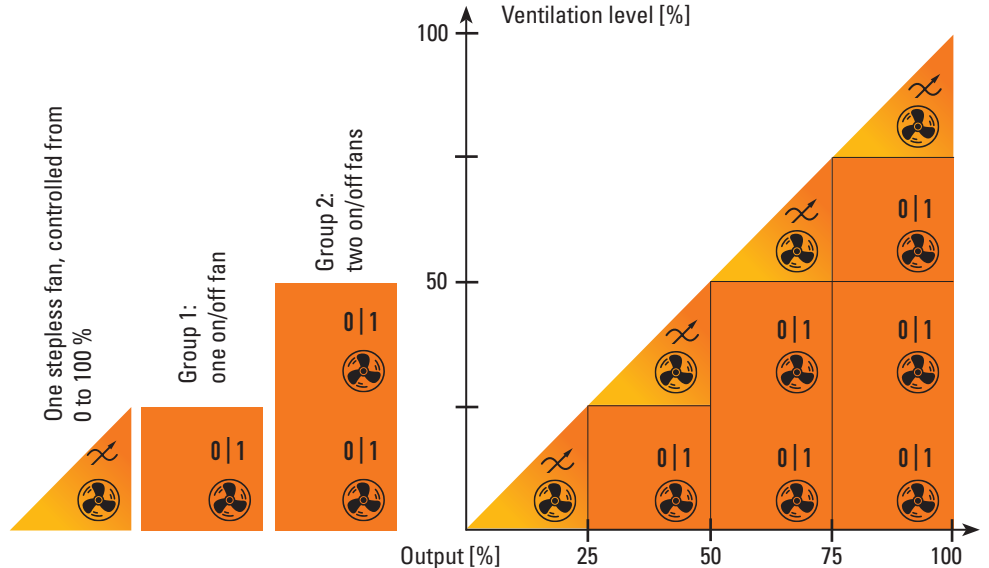

The enhanced version of our well-proven MultiStep principle is called **Dynamic MultiStep**. This principle can save even more energy, especially when combined with the new and controlled AirMaster Blue 130C and 140C fans. Compared to the already very energy-efficient MultiStep solution, the power consumption of the new Dynamic MultiStep exhaust air principle is another 50 percent lower! Instead of starting additional fans at 100 percent speed, the fans begin working as early as at 50 percent (depending on the required pressure resistance). Only after all fans have been started one after another at 50 percent is their speed increased simultaneously to 100 percent when the ventilation demand requires this.

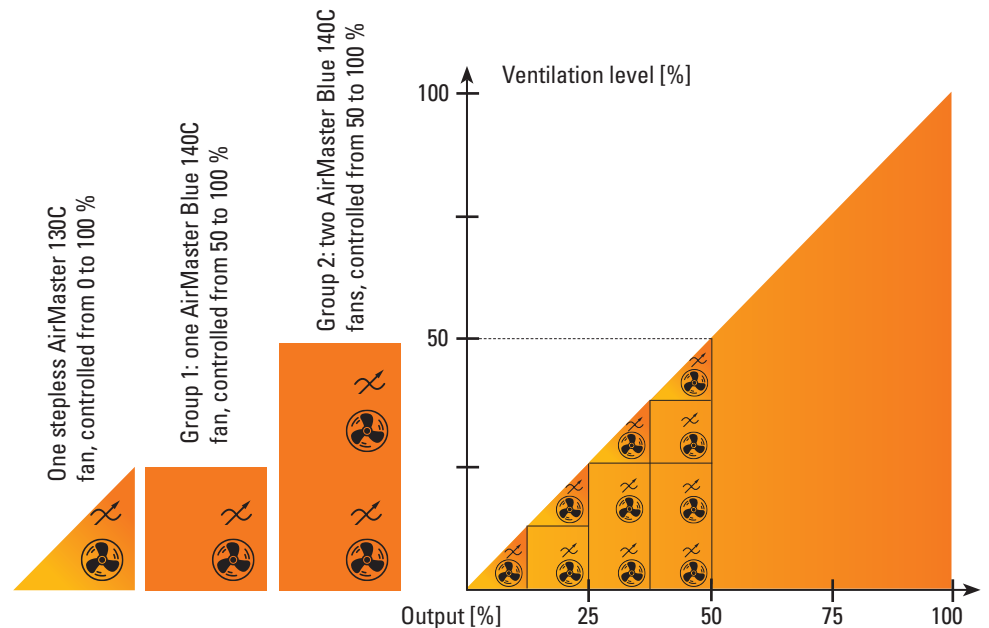

AirMaster 130/130C

High air performance and low costs

With regard to its air flow rates, AirMaster 130 is the smallest fan of the AirMaster series. Like all AirMaster fans, AirMaster 130 is mainly installed in the gable and also available with a cone.

The metal housing has a long-lasting zinc-aluminium coating. The specially shaped blades are made of glass fibre reinforced plastic. Air guide rails on every blade ensure a high air performance combined with a low resistance and thus low energy consumption. The airflow opens the shutters, which are

then kept open without any losses by means of a balancing weight. When the fan stops, the shutters close automatically and are locked magnetically. The V-belt pulley is made of aluminium and is manufactured as one piece together with the blade hub by diecasting. The V-belt is pre-tensioned, i.e. a belt tensioner is not necessary. Big Dutchman uses high-quality and highly efficient IE3 motors with a large voltage range (motor protection rating IP 55). The motors are completely closed; a separate

cooling fan is not necessary. This means that there is no danger of dust entering the motor, protecting it from overheating.

AirMaster EVO 130/130C:

With one frequency transformer for each fan, the fan speed can be reduced continuously by up to 30 percent. Reducing the speed by just ¼ reduces energy consumption by half!

Advantages

- ✓ high air performance;
- ✓ specially shaped blades ensure optimum operation, thus reducing energy costs;
- ✓ low noise level;
- ✓ compact design;
- ✓ air flow pressure opens the shutters, which stay open thanks to balancing weights: little air resistance;
- ✓ rugged design;
- ✓ good price : performance ratio;
- ✓ simple assembly without external assistance;
- ✓ long service life.



AirMaster 130C

AirMaster 130

- 1 Electric motor without cooling fan: well-protected against dust, no overheating
- 2 Central V-belt pulley made of aluminium with pre-tensioned V-belt: no V-belt tensioner necessary
- 3 Stable connection between hub and blade: copes well with high loads
- 4 Specially shaped blades made of glass fibre reinforced plastic with air guide rails: optimum air performance and minimum load on the bearing thanks to the blades' low weight
- 5 All four corners equipped with plastic covers: no dirty corners, good hygiene
- 6 Diagonal braces for improved stability
- 7 Airflow opens the shutters: no centrifugal system required

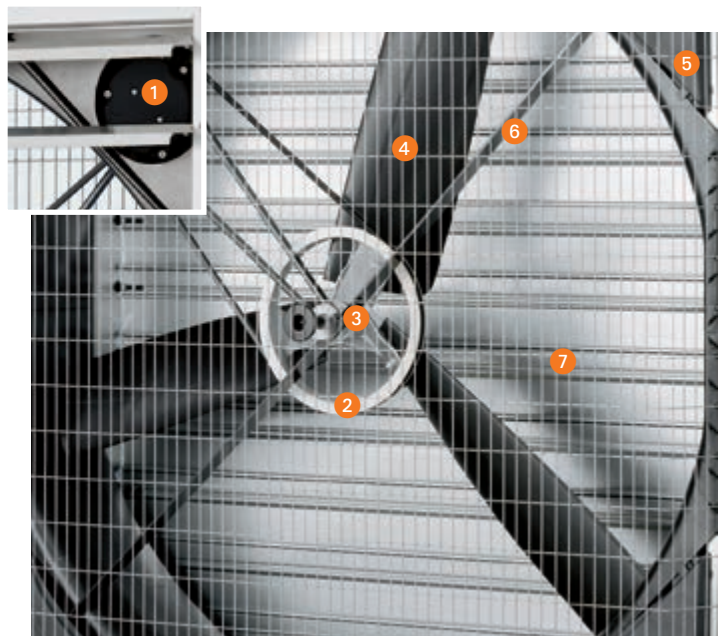

AirMaster 140/140C

High air performance and pressure resistance of up to 100 Pa

AirMaster 140 fans feature a higher air performance, especially when dealing with high counterpressure. They are therefore a good choice in barns with tunnel ventilation if the housing equipment causes high resistance and thus makes an unobstructed airflow impossible.

Material quality, aerodynamics and workmanship meet the same high requirements as AirMaster 130, while the following quality features additionally apply for AirMaster 140 fans:

- blades with higher stability
- V-belt pulley with higher stability
- connection between hub and the six blades with higher stability
- use of 2.0 HP IE3 motors (high energy efficiency) according to the European Ecodesign Directive

AirMaster EVO 140/140C:

With one frequency transformer for each fan, the fan speed can be reduced continuously by up to 30 percent. Reducing the speed by just ¼ reduces energy consumption by half!



AirMaster 140

The AirMaster 140 fan is also available with a cone. This cone reduces power consumption even further, while also increasing air performance. This is due to the so-called Venturi effect, where the air from the barn has to flow through a narrow part of the fan and then spreads like a diffuser: the exhaust air flows better. A pressure loss of 10 to 15 Pa can be prevented in this manner. Thanks to the cone, the shutter is well-protected against the weather. AirMaster 140 needs slightly more space in the gable.



AirMaster 140C with wire mesh guard

Advantages

- ✓ high air performance;
- ✓ pressure resistance of up to 100 Pa;
- ✓ specially shaped blades ensure optimum operation, thus reducing energy costs;
- ✓ low noise level;
- ✓ air flow pressure opens the shutters, which stay open thanks to balancing weights: little air resistance;
- ✓ stable and robust construction;
- ✓ compact design;
- ✓ good price : performance ratio;
- ✓ simple assembly without external assistance;
- ✓ long service life.

Dimensions of the AirMaster 130 / 140 fans

Type	A	B	C	D	E
	in mm				
130	1380	1380	522	1284	
130C	1380	1380	1275	1284	1600
140	1480	1480	548	1375	
140C	1480	1480	1340	1375	1660

The fans must be equipped with a wire mesh guard on the shutter side where they are installed at a height of less than 2.70 m and accessible for persons.

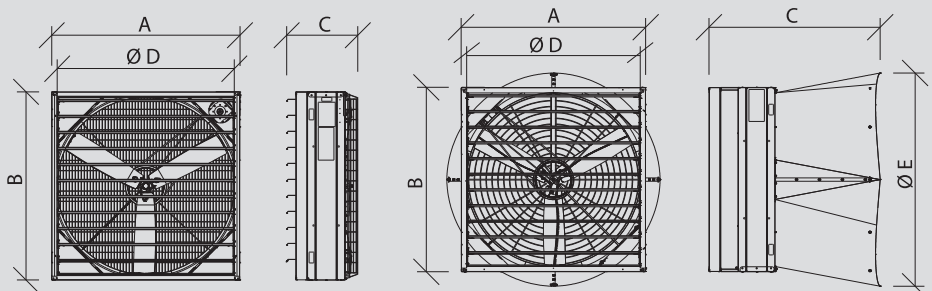

AirMaster Flex 140C

High air performance, low energy consumption and good resistance to corrosion

AirMaster Flex 140C is a new cone fan that combines the best of two worlds. This fan model is equipped with a V-belt driven, high-quality and very efficient IE3 motor, which can be provided for any type of power supply. Additionally, housing and cone are made of a high-quality, corrosion-resistant plastic

material. A very important feature is the optimised aerodynamic design of the intake nozzle. The exhaust air is removed from the barn without any turbulences, which leads to a high air performance and low power consumption.

The motorized and well-insulated shutter is

absolutely airtight and therefore ideal for the colder season. An emergency opening can also be connected.

With a cone diameter of 1750 mm, AirMaster Flex 140C is the largest fan of the Big Dutchman product range.



AirMaster 140C with V-belt driven motor and an aerodynamic intake nozzle



AirMaster Flex 140C with wire mesh guard and motorized shutter

Advantages

- ✓ high air performance;
- ✓ resistance to pressure;
- ✓ excellent aerodynamic design of the intake nozzle;
- ✓ cost-efficient but high-quality IE3 motor that can be provided for any type of power supply;
- ✓ low noise level;
- ✓ high-quality materials: fan made of polypropylene and stainless steel for corrosion prevention;
- ✓ shutter closes airtight and is well-insulated and therefore ideal for the colder season;
- ✓ an important emergency opening system can be connected;
- ✓ good price : performance ratio;
- ✓ long service life;
- ✓ unassembled upon delivery for a low shipping volume and thus lower transport costs.

Dimensions of the AirMaster Flex 140C fan

- A = 1700 mm = 67"
- B = 1700 mm = 67"
- C = 1256 mm = 50"
- D = 1397 mm = 55"
- E = 1750 mm = 69"

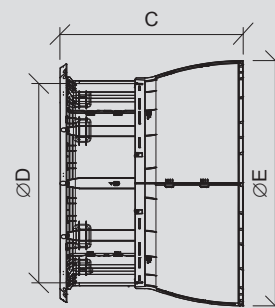
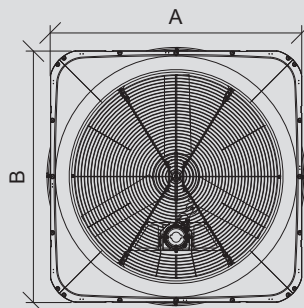

The fan must be equipped with a wire mesh guard in front of the shutter where it is installed at a height of less than 2.70 m and accessible for persons.

AirMaster Blue 140C

Very high air performance, stepless control, high energy savings and corrosion resistance

The AirMaster fans of the **Blue** series are a new addition to the Big Dutchman product range. They are next-generation fans and feature a directly driven, steplessly variable motor. The AirMaster Blue 140C fan has five outstanding characteristics:

- very high air performance
- minimum energy consumption
- high resistance to pressure
- optimized aerodynamic design
- very high resistance to corrosion

The AirMaster Blue 140C fan has the same dimensions as AirMaster Flex 140C.



The perfect aerodynamic design of the intake nozzle leads to a high air performance



AirMaster Blue 140C

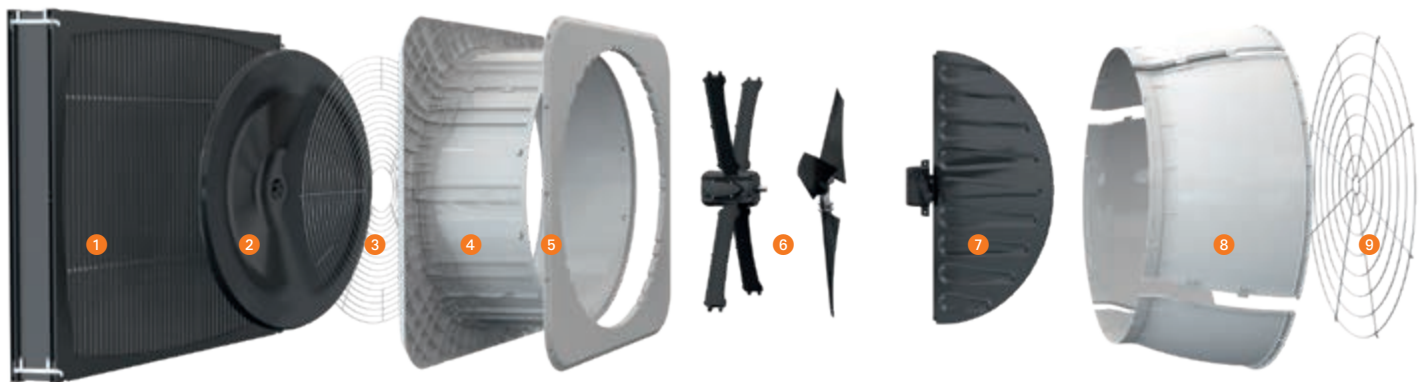

Components of AirMaster Blue 140C

- ➊ Light trap (optional): available in two versions
- ➋ Insulation cover (optional): easy to install
- ➌ Wire mesh guard
- ➍ Housing: optimized aerodynamic design
- ➎ Wall cover (optional)
- ➏ Energy-saving PM motor with impeller: direct drive
- ➐ Motorized shutter: an emergency opening connection is possible, very airtight
- ➑ Cone: aerodynamic shape
- ➒ Wire mesh guard

Advantages

- ✓ as a steplessly variable fan and in combination with the Dynamic MultiStep exhaust air principle, currently the most energy-efficient solution for ventilating livestock buildings;
- ✓ high resistance to pressure of up to 100 Pa;
- ✓ very low noise level;
- ✓ directly driven, with a stable connection between hub and blade for low maintenance requirements;
- ✓ motorized shutter closes the fan airtight;
- ✓ an important emergency opening system can be connected;
- ✓ high material quality: fan made of polypropylene and stainless steel;
- ✓ protection rating IP 65;
- ✓ unassembled upon delivery for a low shipping volume and thus lower transport costs.

AirMaster Blue 130 / 130C

High air performance, stepless control from 0 to 100 %, high energy savings and corrosion resistance

The AirMaster Blue 130 fan has the same dimensions as AirMaster 130 and is therefore the ideal solution for retrofitting. This is especially relevant where a fan that can be controlled from 0 to 100 percent, therefore saving considerable energy, should be used. Big Dutchman especially recommends using this fan in pig housing because it is resistant to ammonia and thus also to corrosion. The AirMaster Blue 130 fan can be supplied with or without cone.

The most important feature of this fan is the newly developed **motorized shutter**. This shutter consists of six vertical elements that are opened and closed steplessly from 0 to 100 percent by a motor. The V-shaped arrangement of the elements means that the air is removed in a laminar flow, i.e. without turbulences. The fan therefore runs very smoothly, without vibrations. Using the controlled shutter and the EC motor, both the MultiStep and the Dynamic MultiStep principles can be implemented. This allows for great energy savings and ensures that your livestock enjoy a comfortable climate at all times.

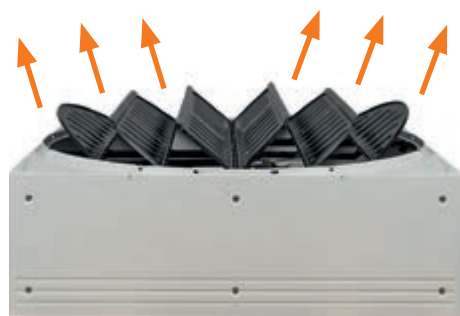

V-shaped, motorized shutter



AirMaster Blue 130

AirMaster Blue 130C

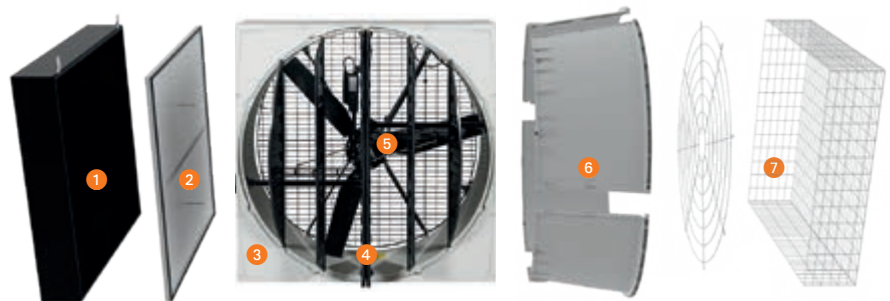

Components of AirMaster Blue 130 and 130C

- 1 LameliaBrown high trap (optional)
- 2 Insulating plate (optional): easy to install
- 3 Housing: optimized aerodynamic design
- 4 Motorized shutter: an emergency opening connection is possible, very airtight
- 5 Energy-saving, controlled EC motor with impeller: direct drive
- 6 Cone: aerodynamic shape
- 7 Wire mesh guard/protective cage

Advantages

- ✓ steplessly variable from 0 to 100 percent and in combination with the MultiStep und Dynamic MultiStep exhaust air principles currently the most energy-efficient solution for ventilation;
- ✓ high resistance to pressure of up to 100 Pa;
- ✓ very low noise level;
- ✓ motorized shutter closes the fan airtight;
- ✓ an important emergency opening system can be connected;
- ✓ directly driven, with a stable connection between hub and blade for low maintenance requirements;
- ✓ high-quality materials: fan made of polypropylene and stainless steel for corrosion prevention;
- ✓ protection rating IP 65;
- ✓ assembled upon delivery for a fast installation on site.

Technical data for AirMaster 130/140/Flex 140: 3 ~ 400 V, 50 Hz

Description details

V130-3-1.5 HP

V = fan without cone

130/140 = impeller diameter

3/6 = number of blades

VC 140-6-2.0 HP

VC = fan with cone

1.5/2.0 = motor power

	V130-3-1.5 PS E15	VC130-3-1.5 PS E15	V140-6-2.0 PS E15	VC140-6-2.0 PS E15	BD-Flex-140C-3-2.0 PS E15
Code no.	60-25-4541	60-25-4556	60-25-5100	60-25-5650	83-56-1839
Power consumption (in watts)	1600	1550	1550	1500	1200
Nominal current (in ampere)	3.0	2.9	3.2	3.1	2.7
Sound level (in dB(A))*	64	64	63	66	

* at a distance of 7 m

AirMaster 130/140/Flex 140C: air flow rate (m³/h) / specific fan power (W/1000 m³/h)

Type / negative pressure	0 Pa	20 Pa	30 Pa	40 Pa	60 Pa	80 Pa	100 Pa
V130-3-1.5 HP	46700 / 34.5	42600 / 39.1	40700 / 41.0	38300 / 44.1	31900 / 53.4		
VC130-3-1.5 HP	50700 / 30.7	47000 / 34.8	45000 / 37.0	42600 / 40.1	37800 / 46.1		
V140-6-2.0 HP	46200 / 33.4	43700 / 37.9	42400 / 40.8	41000 / 43.8	37600 / 50.4	34100 / 58.9	29500 / 69.5
VC140-6-2.0 HP	47900 / 31.1	45400 / 35.9	44100 / 38.4	42800 / 40.8	39800 / 46.8	35600 / 55.5	30800 / 65.7
BD-Flex-140C-3-2.0 HP	53000 / 22.9	48300 / 28.4	45700 / 31.4	43100 / 34.6	37200 / 42.0		

Fans with other voltages and frequencies are available upon request.

AirMaster Blue 130C, 3 ~ 400 V: air flow rate (m³/h) and specific fan power (W/1000 m³/h)

Type / negative pressure	Code no.	0 Pa	20 Pa	40 Pa	60 Pa	80 Pa	100 Pa
BD-Blue 130C-7 (50/60 Hz)	60-25-4588	53800	49100	44900	40600	34700	28200
– spec. fan power W/1000 m³/h		32	37	41	46	53	74
BD-Blue 130C-6 (50/60 Hz)	60-25-4591	48600	43900	39500	33700	27400	
– spec. fan power W/1000 m³/h		27	32	36	42	51	
BD-Blue 130-7 (50/60 Hz)	60-25-4562	48900	44900	41100	36600	31600	25000
– spec. fan power W/1000 m³/h		39	43	47	51	58	69
All controlled AirMaster Blue 130 and 130C fans can be operated at a very low speed, allowing for great energy savings!							
BD-Blue 130C on/off (50 Hz)	60-25-4599	48400	44600	39000	32700	25700	
– spec. fan power W/1000 m³/h		31	35	40	48	59	
BD-Blue 130 on/off (50/60 Hz)	60-25-4586	45100	41300	36300	30300	20100	
– spec. fan power W/1000 m³/h		35	39	45	51	59	

Fans with other voltages and frequencies are available upon request.

AirMaster Blue 140C, 3 ~ 400 V: air flow rate (m³/h) and specific fan power (W/1000 m³/h)

Type / negative pressure	Code no.	0 Pa	20 Pa	40 Pa	60 Pa	80 Pa	100 Pa
BD-Blue 140C-5 (50/60 Hz)	60-25-3708	55700	51000	45800	40100	34500	
– spec. fan power W/1000 m³/h		18	23	28	35	42	
BD-Blue 140C-6 (50/60 Hz)	60-25-3711	65800	61700	57800	53300	48600	43200
– spec. fan power W/1000 m³/h		25	30	35	41	47	58
BD-Blue 140C on/off (50 Hz)	60-25-3714	59600	56300	52400	48200	43700	39200
– spec. fan power W/1000 m³/h		27	32	37	43	50	57

The speed of all controlled AirMaster Blue 140C fans can be reduced significantly: a great potential for saving energy!

BD-Blue 140C-4/-5/-6 (50/60 Hz)		33000	24900	22000			
– spec. fan power W/1000 m³/h		6	11	21			

Fans with other voltages and frequencies are available upon request.

Extensive testing of the BESS (Bioenvironmental and Structural Systems) Laboratory of the University of Illinois, USA, confirms efficiency and quality of the AirMaster Blue 140C fan.



LameliaBrown

Perfect light trap for the entire AirMaster series

The LameliaBrown light trap, newly developed by Big Dutchman, has a light reduction factor of 6000:1 and is thus perfect for use in layer and broiler houses. It has the following advantages:

- ✓ only a low reduction of the fans' air performance;
- ✓ no incidence of direct sunlight;
- ✓ light trap segments made of high-quality plastic for a long service life and easy cleaning;
- ✓ fast installation thanks to the integrated spacers.

If all AirMaster fans are installed together in the gable, constructing a "false wall" may make sense. This false wall is a light trap wall that is fitted into the height and width of the gable. A disadvantage is that e.g. manure removal is no longer possible at this end of the barn because there are no more access points.

If the AirMaster fans are installed to the right and left of the barn's long sides, the light trap wall is installed in a so-called "dog house", similar to a pad cooling system. The advantage of both options is that pressure and output losses are much lower than when using one light trap per fan.



LameliaBrown

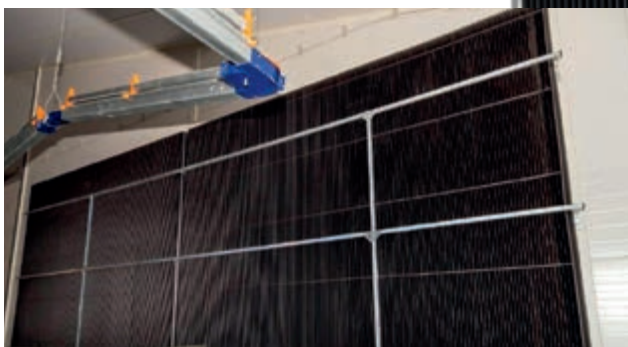

Light trap wall in the gable

Axial fans

Excellent controllability, low power consumption

Axial fans are perfect for installation in the wall, especially in smaller barns and when using cross ventilation. Their frame has an aerodynamic shape and is made of stable plastic or corrosion-resistant metal. The blades are made of aluminium in a moulded diecasting process and are exceptionally efficient.

Big Dutchman differentiates between FC, FF and FN fans, based on the shape of the blades. The serrated blades of the FF and FN fans imitate the wings of an owl during its silent flight (bionics). FF and FN fans therefore consume less power; they are extremely resistant to pressure and operate at a low noise level.

Advantages

- ✓ excellent controllability;
- ✓ low energy consumption, especially of the FF and FN fans;
- ✓ low noise level;
- ✓ fast and easy installation;
- ✓ high corrosion resistance;
- ✓ long service life.



Fan of the FC series



Fan of the FF series



Fan of the FN series

Technical data of the axial fans

Description details

FC071-6EQ	FC = standard fan	071 = impeller diameter (cm)	E = single-phase	
FF063-6DQ	FF = sickle-shaped fan	6 = 6-pole	D = three-phase	Q = wall installation
FN091-6DQ	FN = sickle-shaped fan			

	FF063-6EQ	FC071-6EQ	FF091-6EQ	FF063-6DQ	FC071-6DQ	FF091-6DQ	FN091-6DQ
Code no.	60-47-7904	60-47-9171	60-47-7908	60-47-7905	60-47-9671	60-47-7909	60-50-0216
Power consumption (in watts)	520	890	940	540	890	920	1950
Nominal current (in ampere)	2.5	4.1	4.2	1.3	1.8	1.9	4.0
Sound level (in dB(A))*	46	54	49	46	55	50	53

* at a distance of 7 m

Ventilation performance data

1 ~ 230 V, 50 Hz: air flow rate (m³/h) / specific fan power (W/1000 m³/h)

Type / negative pressure	0 Pa	10 Pa	20 Pa	30 Pa	40 Pa	50 Pa	60 Pa
FF063-6EQ	12110 / 40.4	11700 / 42.7	11280 / 45.2	10830 / 47.5	10350 / 50.2	9810 / 53.0	9100 / 57.1
FC071-6EQ	16080 / 44.1	15650 / 46.6	15180 / 49.4	14670 / 53.1	14130 / 56.2	13560 / 60.1	13020 / 62.9
FF091-6EQ	22760 / 38.4	21660 / 41.1	20600 / 43.6	19590 / 46.4	18460 / 49.5	17460 / 52.9	16470 / 56.1

3 ~ 400 V, 50 Hz: air flow rate (m³/h) / specific fan power (W/1000 m³/h)

Type / negative pressure	0 Pa	10 Pa	20 Pa	30 Pa	40 Pa	50 Pa	60 Pa
FF063-6DQ	12300 / 38.6	11920 / 41.1	11550 / 43.3	11160 / 45.7	10740 / 49.3	10250 / 51.7	9690 / 54.7
FC071-6DQ	16520 / 45.4	16110 / 47.1	15690 / 49.7	15250 / 52.4	14790 / 55.1	14300 / 57.3	13780 / 60.2
FF091-6DQ	23450 / 35.4	22640 / 37.5	21810 / 40.1	20990 / 42.4	19950 / 45.1	18960 / 47.9	18010 / 50.5
FN091-6DQ	27430 / 49.9	26850 / 51.9	26280 / 55.1	25680 / 57.8	25030 / 60.7	24380 / 63.9	23740 / 68.6

The motors are fabricated according to minimum protection rating IP 54.
Additional fan types with other voltages and frequencies are available upon request.

Dimensions

Type	A	B	C	D
	in mm			
FF063	750	805	218	686
FC071	810	850	272	765
FN080	910	970	319	870
FF/FN091	1010	1070	261	1020

A wire mesh guard is required if the fan is installed in an accessible location.

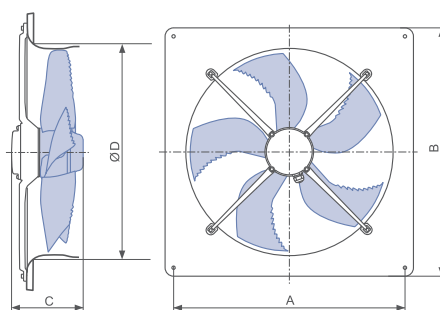

The PVC shutters adjust automatically and close when the fan stops.



Big Dutchman

Europe, Middle East & Africa:
Big Dutchman International GmbH
P.O. Box 1163 - 49360 Vechta, Germany
Tel. +49(0)4447 801-0 · Fax -237
big@bigdutchman.de
www.bigdutchman.de

USA: Big Dutchman, Inc.
Tel. +1 616 392 5981 · bigd@bigdutchmanusa.com
www.bigdutchmanusa.com

Brazil: Big Dutchman (Brasil) Ltda.
Tel. +55 16 2108 5300 · bdb@bigdutchman.com.br
www.bigdutchman.com.br

Russia: 000 "Big Dutchman"
Tel. +7 495 229 5161 · big@bigdutchman.ru · www.bigdutchman.ru

Asia/Pacific: BD Agriculture (Malaysia) Sdn. Bhd.
Tel. +60 3 334 83 555 · bdasia@bigdutchman.com · www.bigdutchman.com

China: Big Dutchman (Tianjin) Livestock Equipment Co., Ltd.
Tel. +86 10 5632 0188 · bdcnsales@bigdutchman.com
www.bigdutchmanchina.com